

CÓRDOBA VCD

Vitrina panorámica Bitempera grupo incorporado R290 / R290 Plug-in panoramic Display counter Bi temperature

El modelo Córdoba con grupo incorporado proporciona una excelente visibilidad del producto gracias a su estructura de cristal de gran transparencia. Puede funcionar tanto en temperatura de refrigeración positiva (3M1 & +2/+4) como negativa (3L1 & -20 / -22) gracias a su unidad "convertible" de alta tecnología. Con esta ventaja, nuestra isla panorámica permite exponer tanto productos envasados de carne, productos lácteos, charcutería y bebidas como productos congelados.

Su unidad condensadora, esta diseñada para facilitar el mantenimiento y el servicio, y su estructura tiene un diseño especial sin tornillos y un sistema de evaporación del agua de desescarche que permite ahorrar energía.

El tamaño compacto de este modelo proporciona una gran flexibilidad en su implantación en tienda que te permite optimizar la distribución de las ventas.

Plug-in Casablanca model that provides excellent product visibility with its highly transparent glass structure; It can operate in both positive (3M1 & +2/+4) and negative (3L1 & -20 / -22) cooling classes with its high-tech "convertible" structure. With this advantage, our cabinet allows the display of both packaged meat, milk, delicatessen and beverage products as well as frozen products.



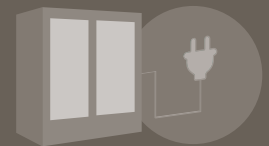

In condensing unit, where you can easily provide maintenance and service, the sheet metal structure has a special design without screw connection and there is a defrost water evaporation system that provides energy saving.

The compact size of the cabinet provides great flexibility in store layout to optimize the sales layout.



Plug-in

Rango de temperaturas / Temperature range

T° Prod.	T° Aplic.
M1: -1/+5°C	0/+2°C
 Carne Meat	 Pescado Fish
 4ª Gama 4TH Range	 Comida preparada Grab & Go
T° Prod.	T° Aplic.
L1: -15/-18°C	-23/-25°C
 Congelados / Helados Frozen foods / Ice creams	



Modelos / Models

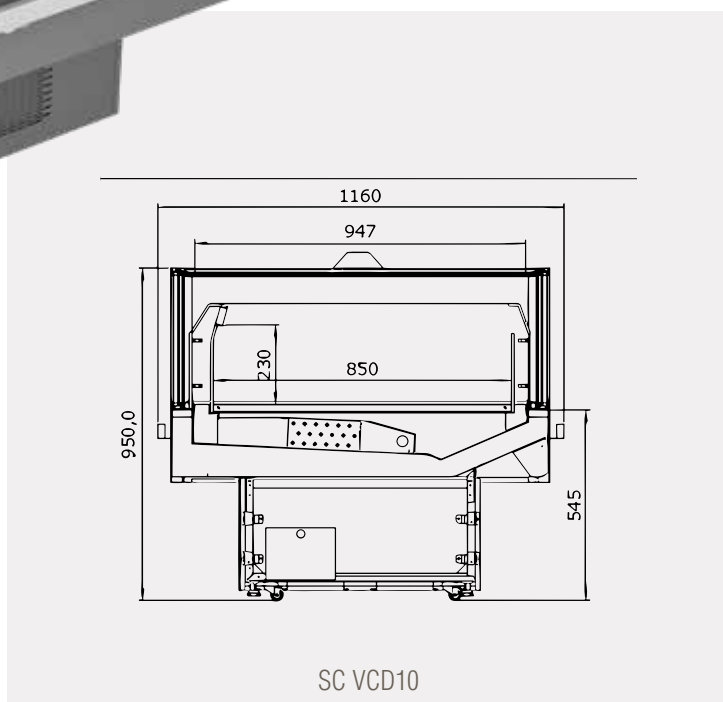

Modelos / Models

MODELO/MODEL	LONGITUD/LENGHT
VCD	10

Longitud (mm) Length (mm)			1250
Altura (mm) Height (mm)	3M1	950	
Temperatura Temperature Class	3L1	-1 / +1 (°C)	
		-22 / -25 (°C)	
Área refrigerada (m²) Loading area (m²)	Anchura (mm) Dept (mm)	1080	1,06
Espesor laterales (mm) End thickness (mm)			42