



# WaterIn

Sistema Waterloop R290 de Infrico

El ahorro energético y el cuidado del medio ambiente son dos factores claves que han impulsado la iniciativa WaterIn

## ¿Qué es WaterIn?

WaterIn son muebles de refrigeración comercial para la conservación de productos refrigerados y congelados, con unidades individuales R290 y sistema de condensación por agua.

## ¿Dónde podemos instalar este sistema?

Este sistema es óptimo para instalaciones que cumplan los siguientes condicionantes.

- Sala de ventas de hasta 1400 m<sup>2</sup> con aproximadamente hasta 40kW frigoríficos.
- Temperatura de trabajo exterior (DryCooler) máxima 48°C.

## ¿Este nuevo sistema requiere un proyecto de instalación?

El sistema WaterIn no requiere instalación frigorífica porque son muebles con la unidad ya instalada y cargada desde fábrica, aunque su implantación requiere un cálculo de instalación para el dimensionamiento de las tuberías de agua, el DryCooler, el sistema hidráulico necesarios y su ubicación etc.

## Beneficios del sistema WaterIn

WaterIn por ser un sistema ecológico y de condensación por agua ofrece múltiples beneficios en la refrigeración comercial. Mayor eficiencia energética, menor impacto ambiental y mejor control de temperatura son solo algunas de sus ventajas.

Saving energy and respect for the environment are two key factors that have driven the WaterIn initiative.

## What's WaterIn?

WaterIn are commercial refrigeration display cases for the preservation of refrigerated and frozen products, with individual R290 units and water condensation system.

## Where do we install this system?

This system is ideal for installations that meet the following conditions:

- Supermarkets up to 1400 m<sup>2</sup> with approximately up to 40kW of refrigeration capacity.
- Outdoor working temperature (DryCooler) max. 48°C.

## Is an installation project required?

The WaterIn system doesn't require refrigeration installation because it's display cases with the unit already installed and loaded from the factory, although its implementation requires an installation calculation for the dimensioning of the water pipes, the DryCooler, the necessary hydraulic system and its location etc.

## Benefits of WaterIn

WaterIn is an environmentally friendly, water condensing system that offers multiple benefits in commercial refrigeration. Greater energy efficiency, lower environmental impact and better temperature control are just some of its advantages.

hasta  
**25%**

Sistema eficiente  
con hasta 25% ahorro de energía

Efficient system with up  
to 25% energy saving

**75%**

75% Reducción carga  
refrigerante

75% Refrigerant charge  
reduction



Mínima carga refrigerante con  
aproximadamente 0,1 kg/kw frigorífico

Minimum refrigerant load with approx.  
0.1 kg/kw refrigerant



Flexibilidad  
de implantación

Flexibility  
of implementation



Posibilidad de recuperación de  
calor en la instalación

Possibility of heat recovery in the  
installation

**0€**

0 € Refrigerantes  
naturales sin tasa

0 € Natural refrigerants  
without charge



Condensadores sin  
mantenimiento

Maintenance-free  
condensers



Posible eliminación, en muchos  
casos, de la sala de máquinas

Possible elimination, in many cases,  
of the machine room



Eliminación de los riesgos típicos  
de las instalaciones centralizadas

Elimination of the typical risks of  
centralised installations



Menor riesgo  
de fugas

Reduced risk  
of leakage



# Waterin

Sistema Waterloop R290 de Infrico



## Unidades R290

condensadas por agua a temperatura positiva

## Water condensed R290

units for refrigerated products

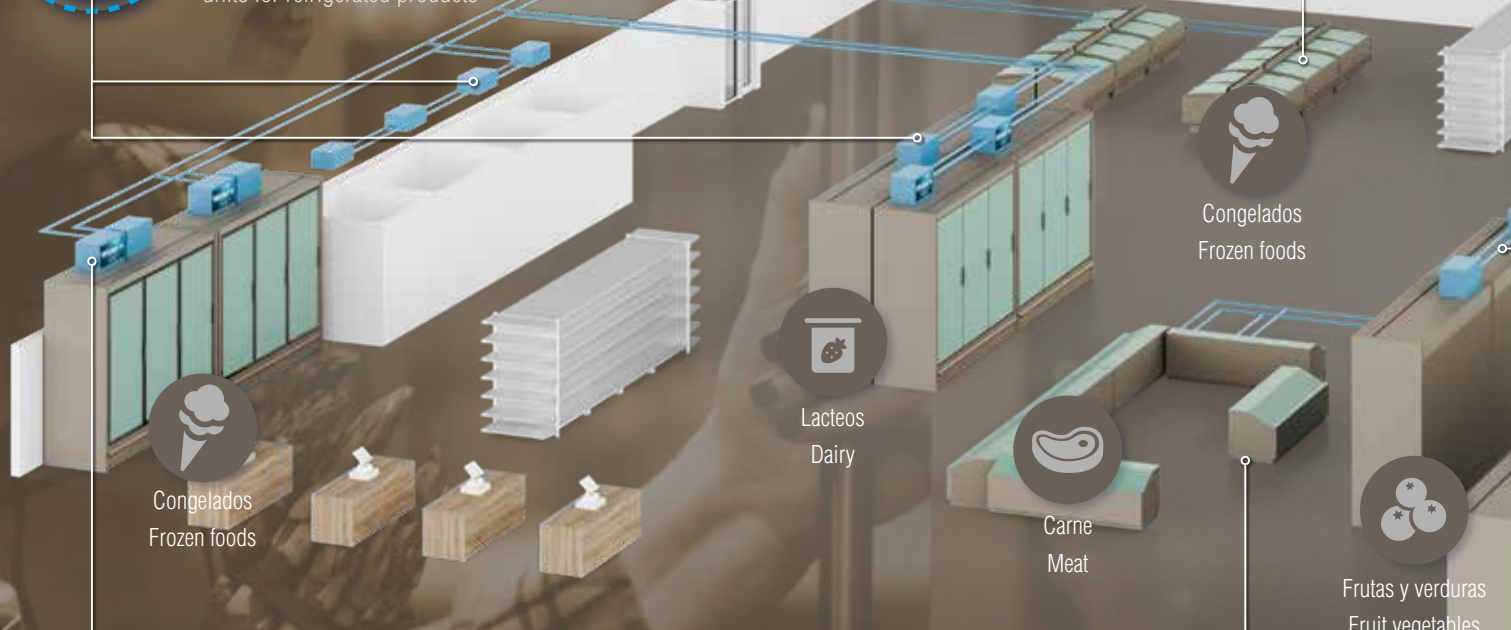

Congelados  
Frozen foods

Lacteos  
Dairy

Carne  
Meat

Frutas y verduras  
Fruit vegetables

Congelados  
Frozen foods



## Unidades R290

condensadas por agua a temperatura negativa

## Water condensed R290

units for frozen products

Unidades R290  
condensadas por agua a temperatura positiva

## Water condensed R290

units for refrigerated products



Posibilidad de recuperación de calor para calefacción o agua caliente sanitaria.  
Heat recovery for heating or domestic hot water

hasta  
**25%**

Ahorro energético  
Ahorro energético

**75%**

Reducción de refrigerante  
Reducción de refrigerante

**0€**

Impuestos  
Impuestos



**Unidades R290**  
 concensadas por agua a temperatura negativa

**Water condensed R290**  
 units for frozen products

**Infrico**  
 Supermarket

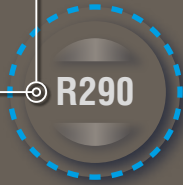
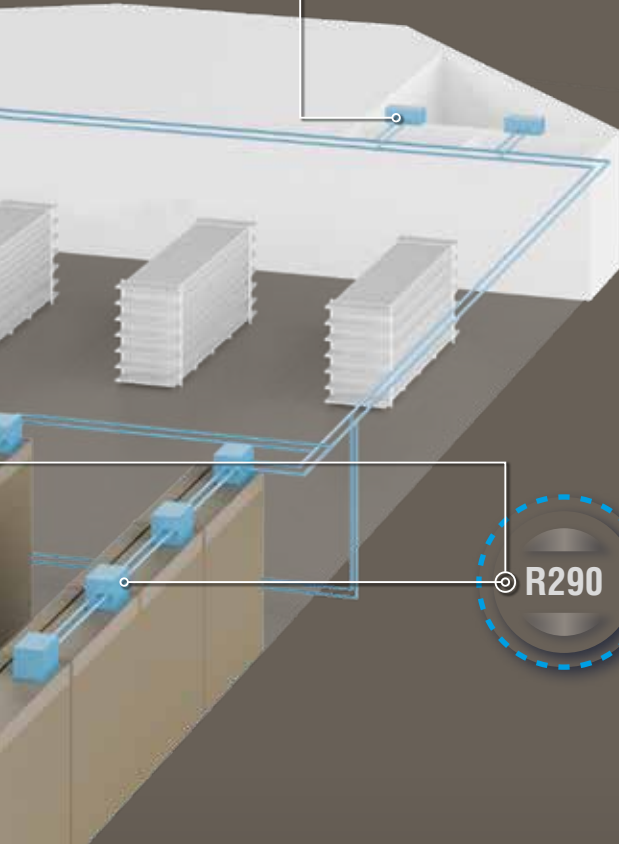

**Unidades R290**  
 concensadas por agua a temperatura positiva

**Water condensed R290**  
 units for refrigerated products

**Familias de productos**  
 Product families

**Murales / Multidecks**



MDGW



MDGW22



MDCW



MPBWH1



MBTW

**Islas / Islands**



GDW



COMBI ASWL1

**Vitrinas Supermarket / Supermarket Counters**



VEXW



VEEW

**Vitrinas Supermarket / Supermarket Counters**



VBCW

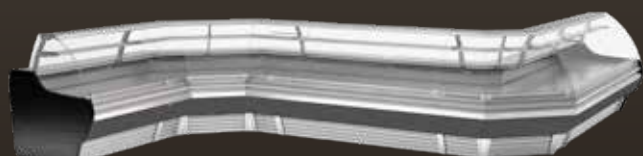

VMDW



# MDGW

Murales Semi Plug-in refrigeración cerradas / Semi Plug-in refrigeration doors multideck







# MDGW / MDGW22

Murales Semi Plug-in refrigeración cerradas / Semi Plug-in refrigeration doors multideck

- Muebles verticales de refrigeración cerrados semi plug in R290 condensación por agua.
- Puertas batientes de cristal doble templado y carga de argón 90% de alta eficiencia.
- Bisagra oleodinámica de cierre suave y automático.
- Estantes regulables e inclinables con portaprecios.
- Iluminación LED 24 V:
  - Color: 2700K, 4000K y carne.
  - Estándar, Premium e Integrade
- Control electrónico.
- Clase climática: Clase 3 25°C/60%HR.
- Datos eléctricos: 230V/50Hz.
- Posibilidades de personalización: Amplia gama de colores, laterales y accesorios.
- R290 Semi plug in closed vertical refrigeration display cases water condensing.
- Double tempered glass hinged doors and high efficiency 90% argon charge.
- Soft-close, self-closing oleodynamic hinge.
- Adjustable and tilting shelves with price holder
- LED lighting 24 V
  - 2700K, 4000K and meat color.
  - Estándar, Premium e Integrade.
- Electronic control.
- Climate class: Class 3 25°C/60%HR.
- 230V/50Hz electrical data.
- Customization: Wide range of colours, end panels and accessories

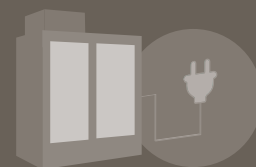

Rango de temperaturas / Temperature range

Semi Plug-in

T° Prod.	T° Aplic.	T° Prod.	T° Aplic.	T° Prod.	T° Aplic.	T° Prod.	T° Aplic.
<b>M0: -1/+4°C</b>	<b>-1/+1°C</b>	<b>M1: -1/+5°C</b>	<b>0/+2°C</b>				
Carne Meat	Pescado Fish	Carne Meat	Pescado Fish	4ª Gama 4TH Range	Comida preparada Grab & Go		
<b>M2: -1/+7°C</b>	<b>+2/+4°C</b>	<b>H1: +1/+10°C</b>	<b>+4/+8°C</b>	<b>L1: -15/-18°C</b>	<b>-23/-25°C</b>		
Charcutería Deli	Bebidas Cold drinks	Lacteos Dairy	Frutas y verduras Fruit vegetables	Congelados / Helados Frozen foods / Ice creams			

Modelos / Models

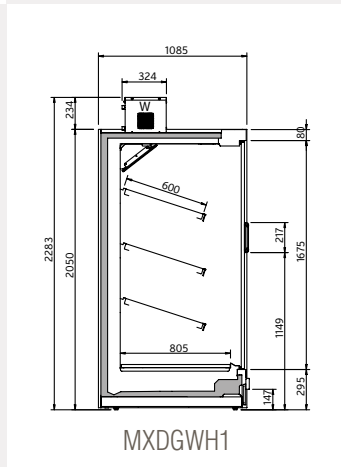
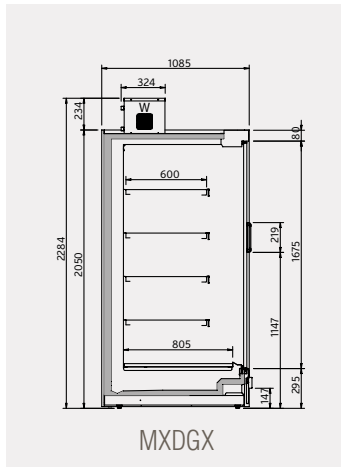
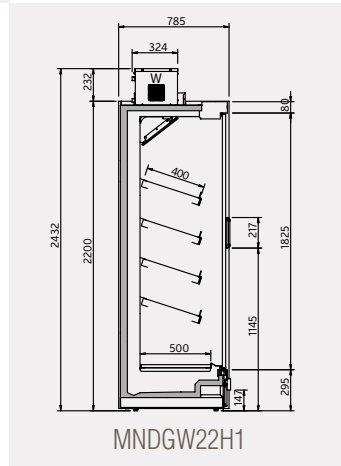
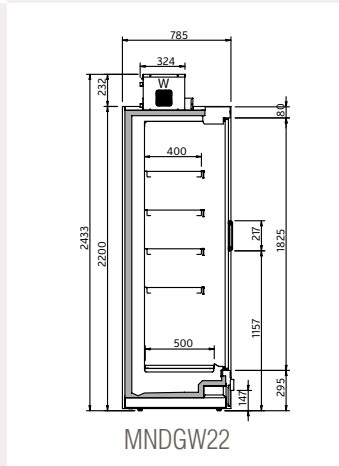
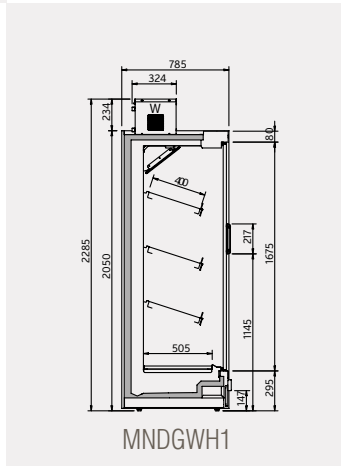
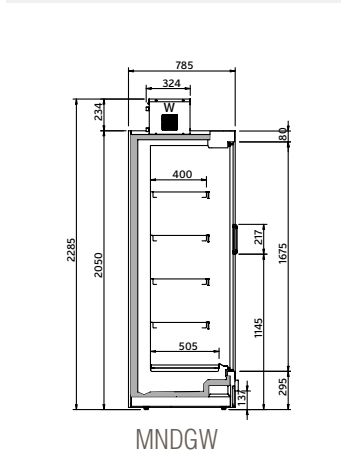
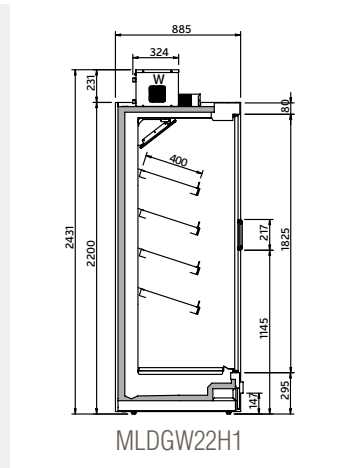
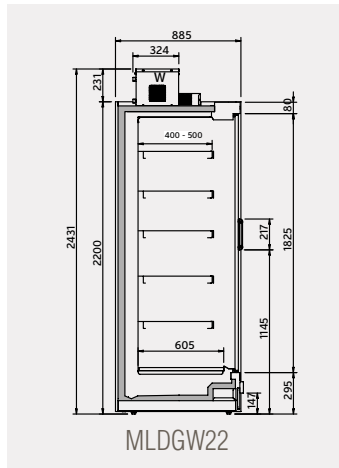
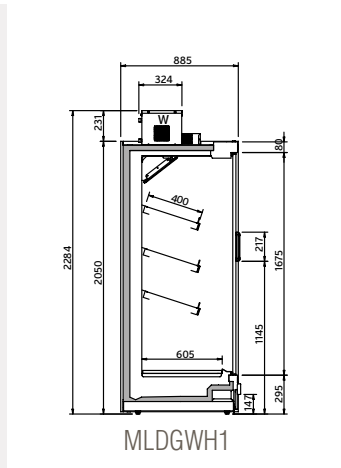
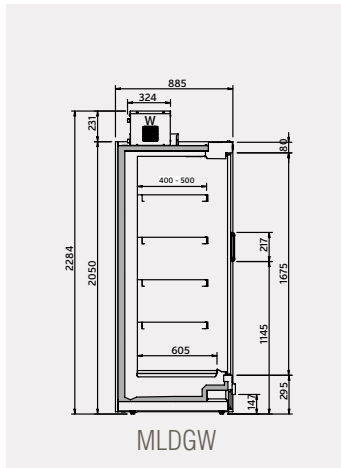

Modelos / Models

MODELO/MODEL	LONGITUD/LENGHT
ML DGWM1	12 18 25 37
ML DGWM2	12 18 25 37
ML DGWH1	12 18 25 37
MN DGWM1	12 18 25 37
MN DGWM2	12 18 25 37
MN DGWH1	12 18 25 37
MX DGWH1	12 18 25 37

MODELO/MODEL	LONGITUD/LENGHT
MX DGWH1	12 18 25 37
ML DGW22M1	12 18 25 37
ML DGW22M2	12 18 25 37
ML DGW22H1	12 18 25 37
MN DGW22M1	12 18 25 37
MN DGW22M2	12 18 25 37
MN DGW22H1	12 18 25 37

Largo / Length

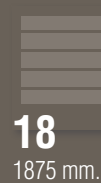
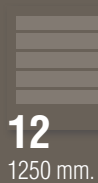
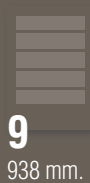

Ancho / Width



Lateral / End panel



Amplio rango dimensional para ofrecer la máxima capacidad.  
Wide dimensional range for maximum capacity.



# Carta de colores murales / Colors chart

## Color exterior / Exterior Color

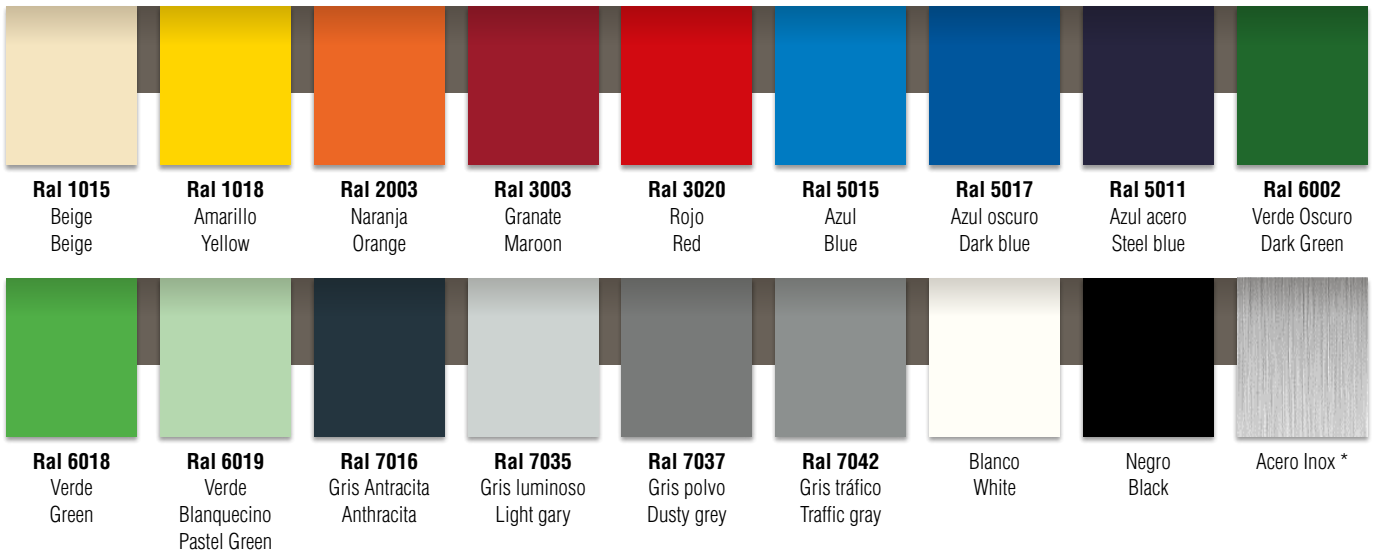

## Color interior / Interior color

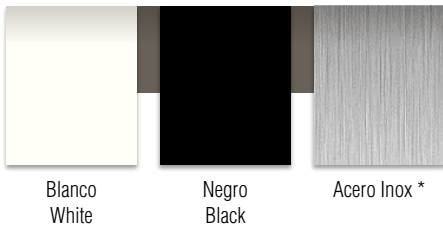

## Ejemplos / Examples



\*Modelos identificados con la letra I

\*Models identified by the letter I

## Experience grupo incorporado / Plugin Experience



**Color interior**  
Blanco o negro

**Color exterior opcional**  
Mueble personalizable

## Experience grupo remoto / Remote Experience



**Color interior**  
Blanco o negro

**Color exterior**  
Opcional

## Laterales / End panels



**Color interior**  
Blanco o negro

**Color exterior**  
Gris Antracita RAL 7016

**Color decoración inferior opcional**  
Mueble configuración estándar



**Lateral**  
Panorámico



**Lateral**  
Display